

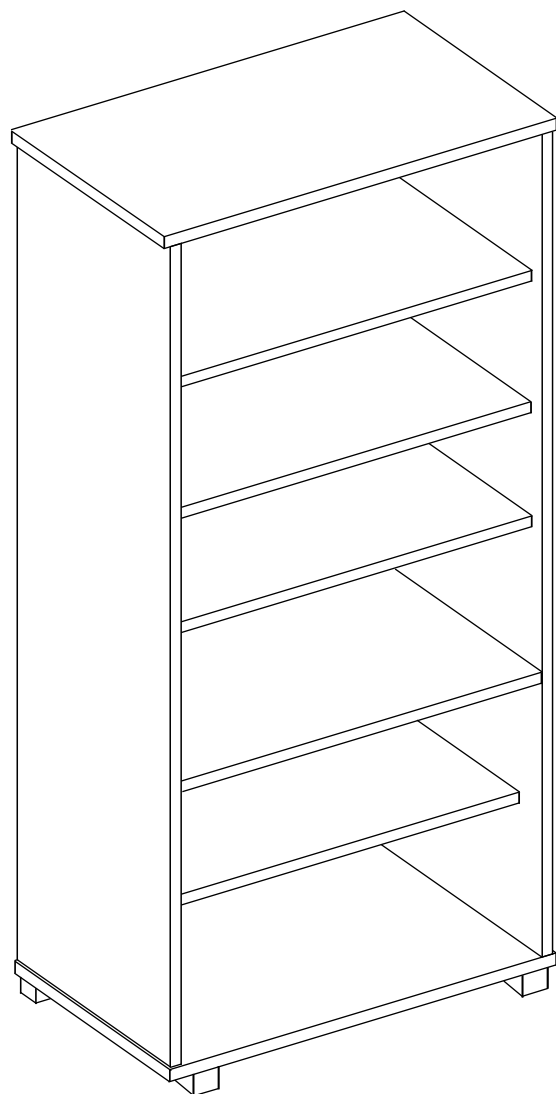

Av. Paranavai, 3263  
Pq. Cidade Industrial  
Cep: 87070-130 - Maringá - PR  
Fone/Fax: (44) 3225-2950  
E-mail: moveisleao@moveisleao.com.br  
Site: www.moveisleao.com.br



#### PARA A LIMPEZA E CONSERVAÇÃO DO SEU MÓVEL



Não use produtos abrasivos como Álcool, Solventes, Acetona e etc...

Use somente um pano macio e seco.

## Livreiro Office







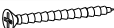

### LISTA DE PEÇAS DO LIVREIRO OFFICE

N°	Cód.	Descrição de Peças	QTD.
01	-	Lateral Esquerda	01
02	-	Prateleira Fixa Maior	01
03	-	Prateleira Fixa Menor	01
04	-	Lateral Direita	01
05	-	Base	01
06	-	Chapéu	01
07	-	Fundo (1845 x 300 x 03)	02
08	-	Prateleira Interna da Porta	01
09	-	Prateleira Móvel	02



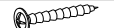

### LISTA DE PEÇAS , PORTAS OPCIONAIS

10	-	Porta Pequena	02
11	-	Porta Grande	02



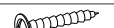

### LISTA DE PEÇAS DO LIVREIRO OFFICE

N°	Acessórios	Qtd.	N°	Acessórios	Qtd.
A	Parafuso 3,5 x 40 	12	F	Pino Prateleira 	12
B	Cavilha 6 x 30 	08	G	Perfil H 	01
C	Prego 8 x 8 	50	H	Giz de Correção 	02
D	Parafuso 4,0 x 30 	04	I	Pé Quadrado 	04
E	Etiqueta 	01			

### LISTA DE ACESSÓRIOS DA PORTA PEQUENA OPCIONAL

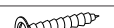
N°	Acessórios	Qtd.	N°	Acessórios	Qtd.
J	Parafuso 4,0 x 25 	04	L	Puxador 	02
K	Parafuso 3,5 x 12 	16	M	Dobradiça 26mm 	04
			N	Calço Dobradiça 	04

### LISTA DE ACESSÓRIOS DA PORTA GRANDE OPCIONAL

N°	Acessórios	Qtd.	N°	Acessórios	Qtd.
J	Parafuso 4,0 x 25 	04	L	Puxador 	02
K	Parafuso 3,5 x 12 	24	M	Dobradiça 26mm 	06
			N	Calço Dobradiça 	06

### DESEMBALANDO

Identifique todas as peças e deixe-as de pé, nunca coloque umas sobre as outras. Utilize a própria embalagem como tapete para a montagem do produto.

### Passo 01

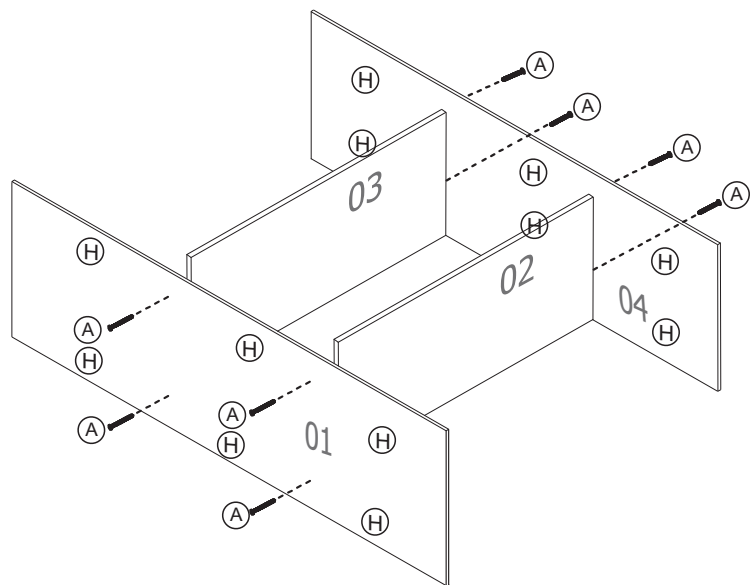

INICIE A MONTAGEM UNINDO AS LATERAIS NAS PRATELEIRAS FIXAS

### Passo 02

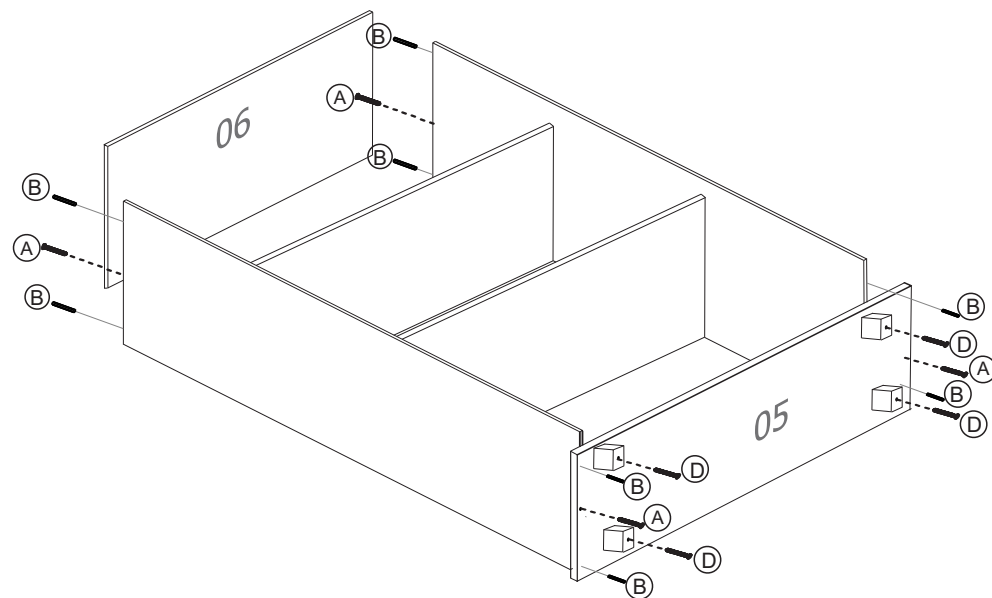

EM SEGUIDA, FIXE OS PÉS NA BASE E UNA A BASE E O TAMPO NAS LATERAIS

### Passo 03

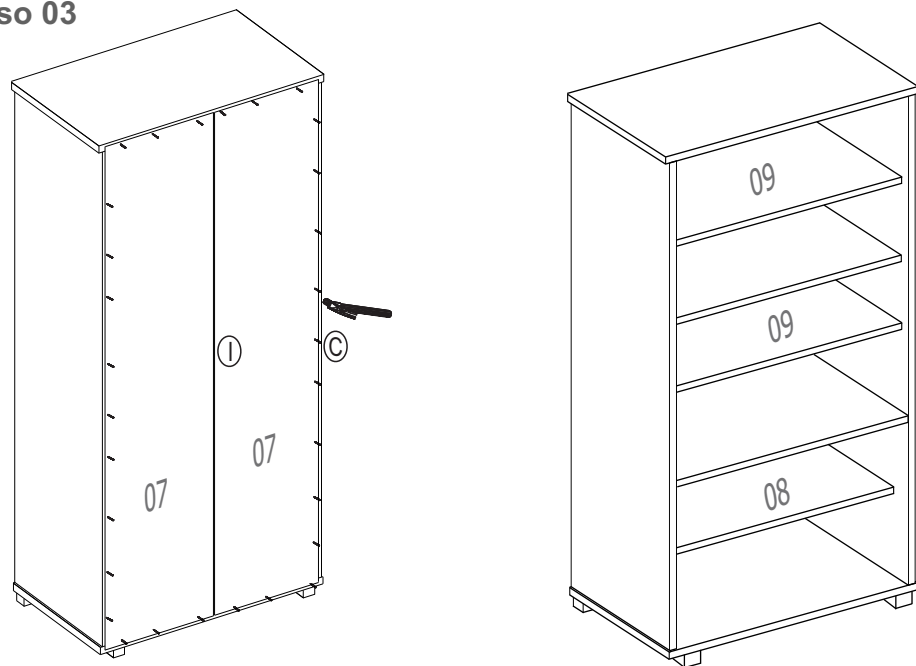

APÓS FIXE OS FUNDOS AO MÓVEL E FINALIZE FIXANDO AS PRATELEIRAS

### Passo 04

## Portas Opcionais

Amigo montador nesse produto damos a opção de vc monta-lo tanto aberto , com 2 portas menores e 2 portas maiores q são vendidas separadamente

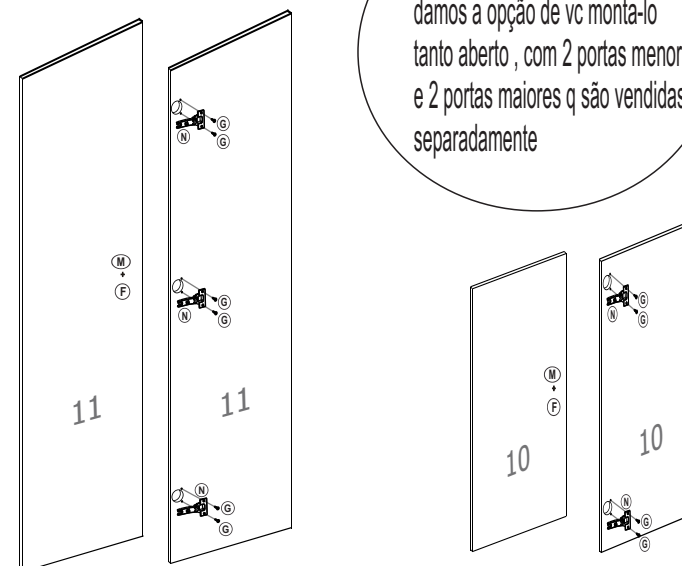

CASO TENHA COMPRADO AS PORTAS OPCIONAIS MONTE-AS E FIXE-AS AO MOVEL