

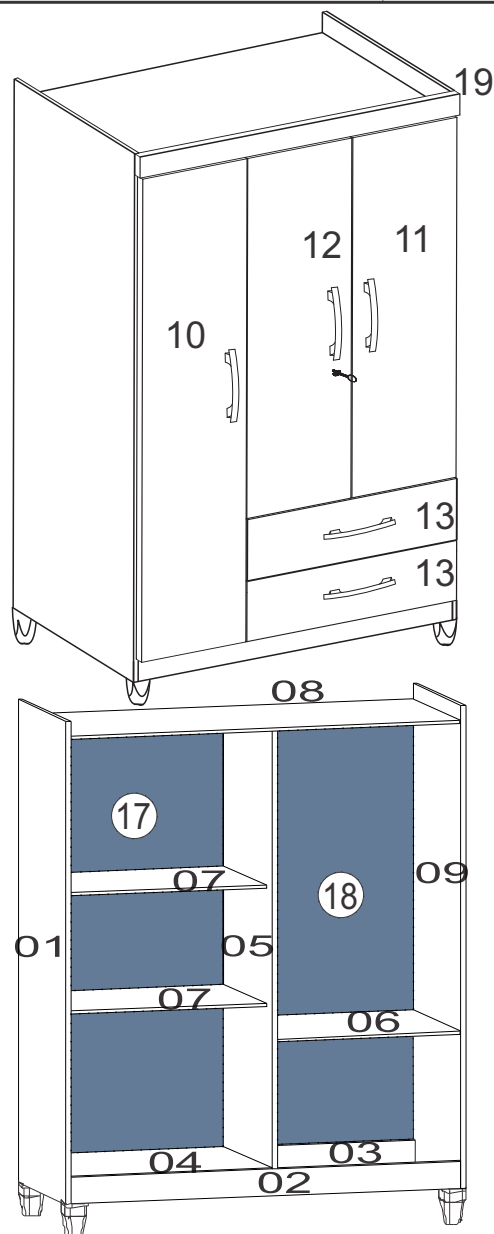









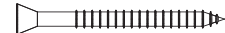
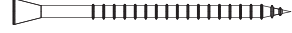













## Roupeiro Lion 3 Portas



LISTA DE PEÇAS		
Nº	Descrição de Peças	QTD.
01	Lateral Esquerda	01
02	Rodapé Frontal	01
03	Rodapé Traseiro	01
04	Base	01
05	Divisão Esquerda	01
06	Tampo da Gaveta	01
07	Prateleiras	02
08	Chapeu	01
09	Lateral Direita	01
10	Porta Grande	01
11	Porta Pequena Direita	01
12	Porta Pequena Esquerda	01
13	Frente de Gaveta	02
14	Lateral de Gaveta	04
15	Contra Fundo de Gaveta	02
16	Fundo de Gaveta	02
17	Fundo Estreito	01
18	Fundo Largo	01
19	Vista Superior	01

	DESCRIÇÃO	QTD
A	 Parafuso 3,5 x 12	86
B	 Parafuso 4,0 x 25	10
C	 Parafuso 3,5 x 40	28
D	 Cavilha 06 x 30	12
E	 Pregos 08 x 08	70
F	 Pregos 13 x 15	08
G	 Prendedor de Fundo	12
H	 Puxador	05
I	 Par de Corrediças	02
J	 Sachet de cola	01
K	 Kit Chave	01
L	 Parafuso 3,0 x 20	05
M	 Suporte Cabideiro Oblongo	02
N	 Cantoneira	09
O	 Porca cilíndrica 9 x 12	16
P	 Dobradiça 26mm	09
Q	 Calço Dobradiça 5mm	09
R	 Giz de Correção	02
S	 Etiqueta	01
T	 Cabideiro	01
U	 Pé cônico	04
V	 Batente p/fechadura reta	01
X	 Trinco 70 x 05	01
Y	 Batente 02 p/ Trinco	01
Z	 Parafuso 4,0 x 25 c/ Porca	08

### DESEMBALANDO

Identifique todas as peças e deixe-as de pé, nunca coloque umas sobre as outras. Utilize a própria embalagem como tapete para a montagem do produto.

### PARA A LIMPEZA E CONSERVAÇÃO DO SEU MÓVEL



Não use produtos abrasivos como Álcool, Solventes, Acetona e etc...

Use somente um pano macio e seco.

### Passo 01

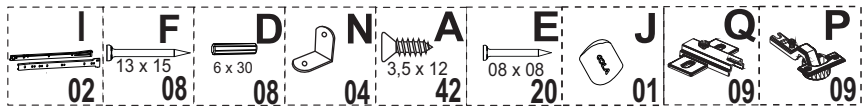

Montagem da gaveta

Montagem Corrediça

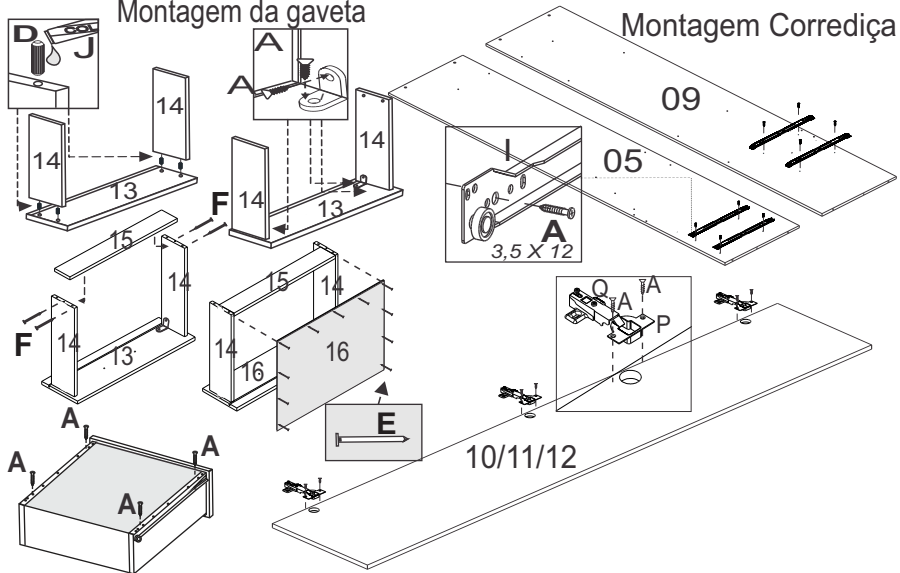

### Passo 02

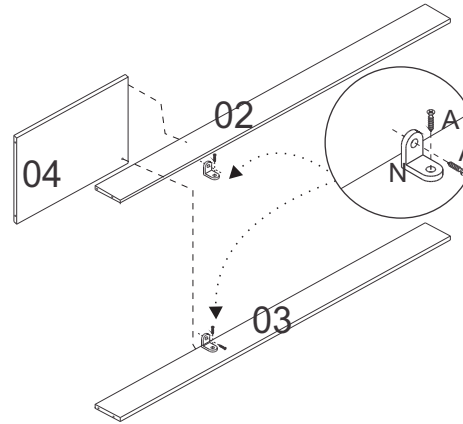
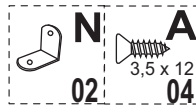

### Passo 03

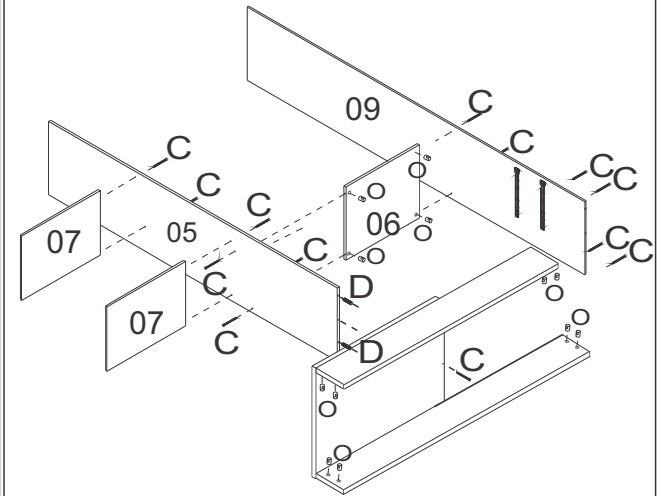
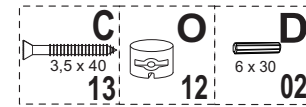

### Passo 04

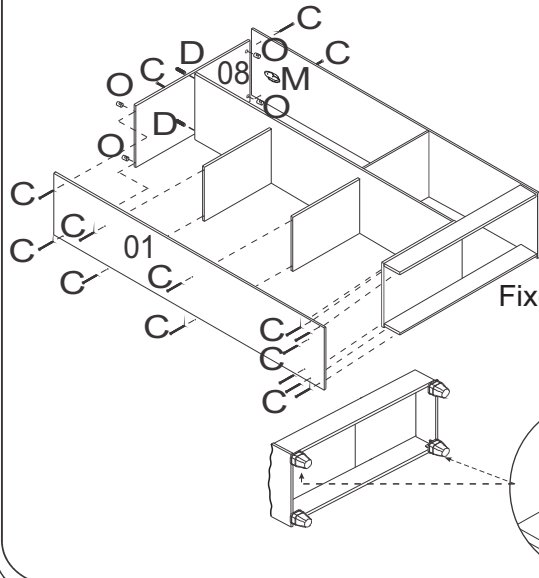
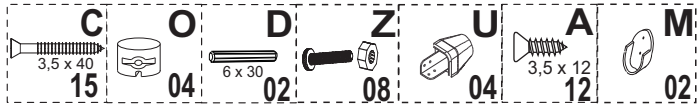

Fixe os pés nos rodapés. Usando uma broca 5mm fure a parte superior do pé e fixe com porca. Q prf 4,0 x 25

### Passo 05

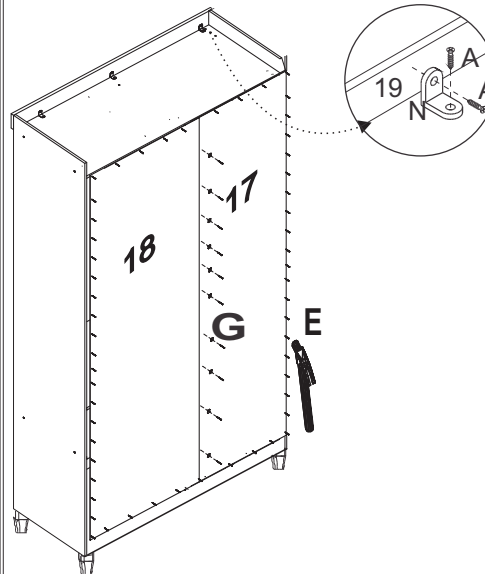
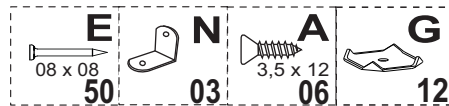

### Passo 06

