

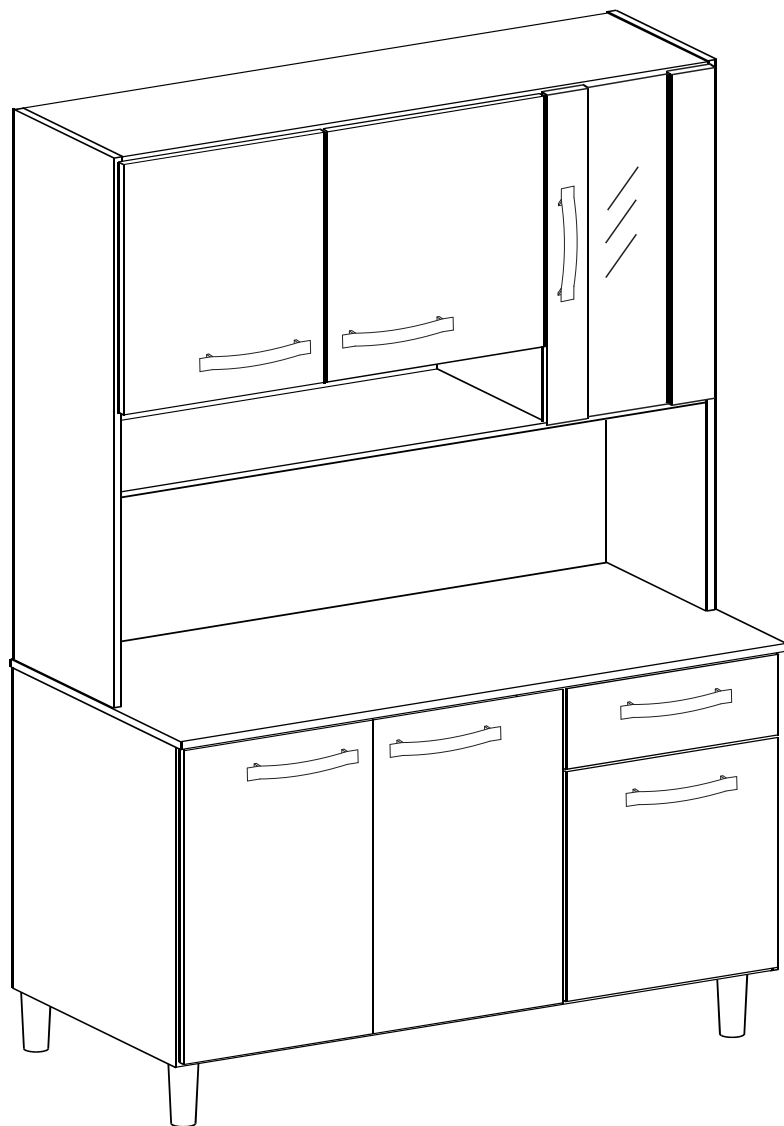

Av. Paranavai, 3263
Pq. Cidade Industrial
Cep: 87070-130 - Maringá - PR
Fone/Fax: (44) 3225-2950
E-mail: moveisleao@moveisleao.com.br
Site: www.moveisleao.com.br











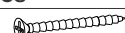









Kit Ana

LISTA DE PEÇAS

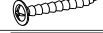
N°	Cód.	Descrição de Peças	QTD.
01	-	Base	01
02	-	Lateral Inferior Esquerda	01
03	-	Prateleira Inferior	01
04	-	Divisão Inferior	01
05	-	Lateral Inferior Direita	01
06	-	Tampo	01
07	-	Lateral Superior Esquerda	01
08	-	Base Superior Central	01
09	-	Divisão Superior	01
10	-	Tampo Superior	01
11	-	Lateral Superior Direita	01
12	-	Prateleira Superior	01
13	-	Chapéu	01
14	-	Porta Inferior	02
15	-	Porta Superior	02
16	-	Porta Inferior Direita	01
17	-	Porta Superior de Vidro	01
18	-	Frente de Gaveta	01
19	-	Lateral de Gaveta	02
20	-	Contra Fundo de Gaveta	01
21	-	Fundo de Gaveta (305 x 260 x 03)	01
22	-	Fundo Inferior (900 x 615 x 03)	01
23	-	Fundo Central (900 x 350 x 03)	01
24	-	Fundo Superior (900 x 605 x 03)	01

LISTA DE PEÇAS

N°	Acessórios	Qtd.	N°	Acessórios	Qtd.
A	Parafuso 3,5 x 40 	15	J	Puxador 	07
B	Parafuso 3,5 x 12 	72	K	Par de Corrediças 	01
C	Parafuso 4,0 x 25 	14	L	Dobradiça 26mm 	12
D	Cavilha 6 x 30 	34	M	Calço Dobradiça 5mm 	12
E	Cavilha 6 x 55 	04	N	Prendedor de Fundo 	14
F	Prego 8 x 8 	55	O	Pé de Kit 	04
G	Prego 13 x 15 	04	P	Cantoneira p. Gaveta 	08
H	Parafuso 5,0 x 40 	04	Q	Cola em Sachet 	01
I	Etiqueta 	01	R	Giz de Correção 	02
			S	Porca Cilindrica 	06

DESEMBALANDO

Identifique todas as peças e deixe-as de pé, nunca coloque umas sobre as outras. Utilize a própria embalagem como tapete para a montagem do produto.

PARA A LIMPEZA E CONSERVAÇÃO DO SEU MÓVEL



Não use produtos abrasivos como Álcool, Solventes, Acetona e etc...

Use somente um pano macio e seco.

Passo 01

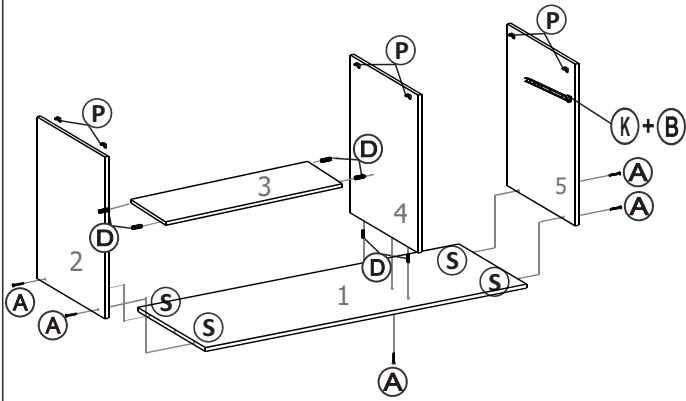

COM O MÓVEL DEITADO, INICIE PELA MONTAGEM DO BALCÃO

Passo 02

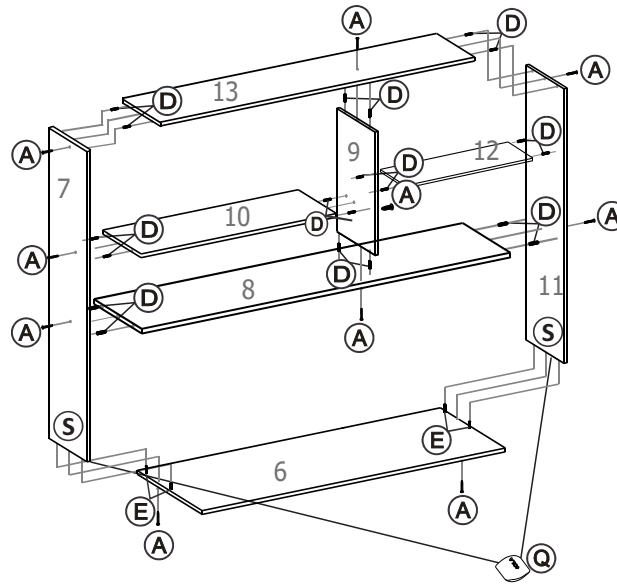

NA SEQUÊNCIA, FAÇA A MONTAGEM DA PARTE SUPERIOR

Passo 03

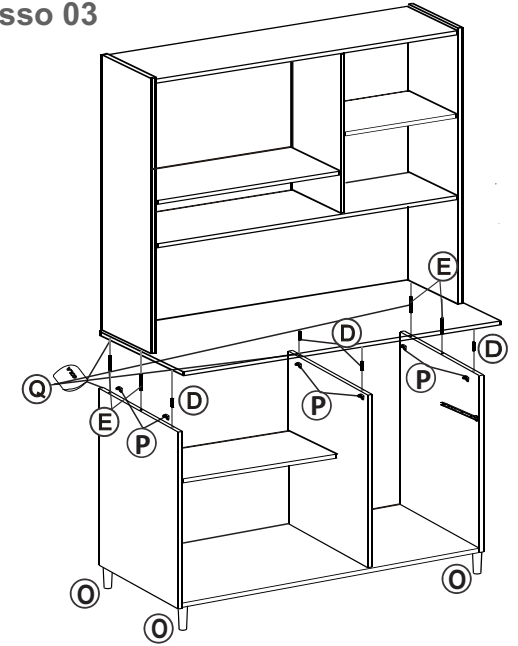

UNA A PARTE SUPERIOR AO BALCÃO, UTILIZE A COLA E AS CANTONEIRAS NA UNIÃO

Passo 04

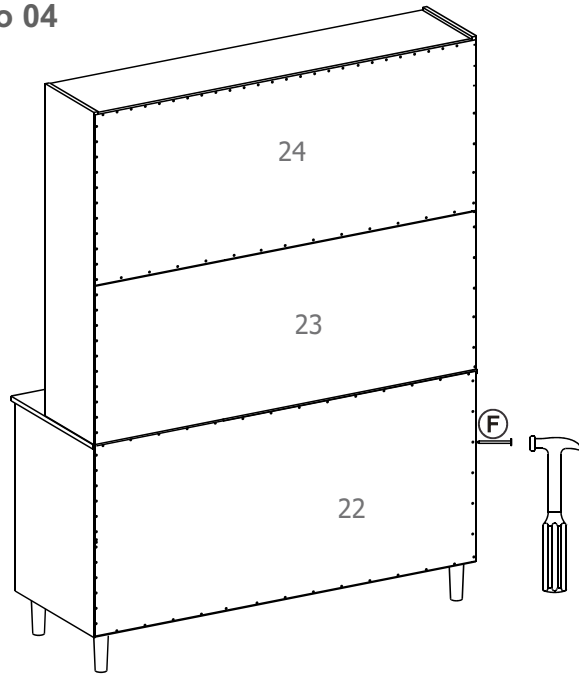

FIXE OS FUNDOS DO MÓVEL

Passo 05

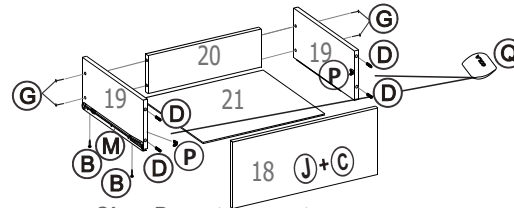

Obs.: Durante a montagem, fixe as correijas na lateral, por baixo do fundo da gaveta. (Peças 19 e 21)

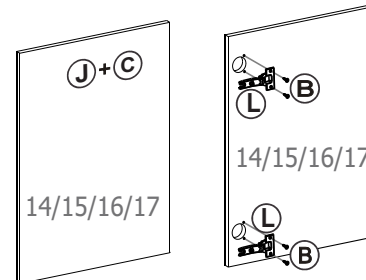

FAÇA A MONTAGEM DAS PORTAS E DAS GAVETAS E ADICIONE SEU PUXADOR

Passo 06

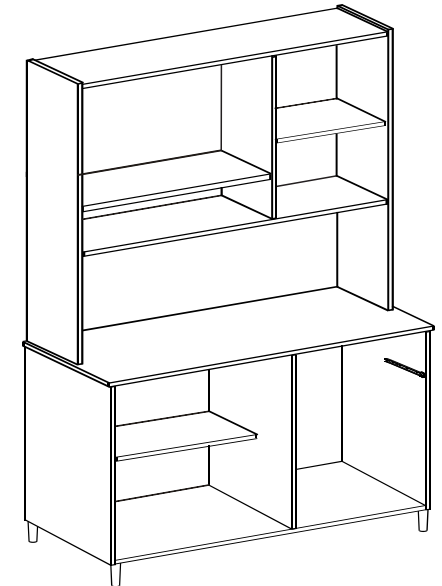

PARA FINALIZAR, ADICIONE AS GAVETAS E AS PORTAS NO MÓVEL.